

---

# GUIDE<sup>®</sup> EasIR-9 Thermal Camera

## User Manual

Wuhan Guide Infrared Co., Ltd.

No. 26 Shucheng Rd, Hongshan District, Wuhan 430070 P. R. China

Telephone: +86-27-8767 1991

Facsimile: +86-27-8767 1927

Email: [overseas@guide-infrared.com](mailto:overseas@guide-infrared.com)

Internet: [www.guide-infrared.com](http://www.guide-infrared.com)

© Wuhan Guide Infrared Co., Ltd., 2010

Publication No: GUIDE<sup>®</sup> EASIR-9UM 001

---

The Quality Management System of Wuhan Guide Infrared Co., Ltd. is approved to ISO9001:2000 for the design and manufacturing, stockholding, in-house repair and site servicing of non-contact temperature measuring instrumentation.

Wuhan Guide Infrared Co., Ltd. reserves the right to make changes and improvements on any of the products described in this manual without prior notice.



**GUIDE® EASIR-9** Thermal Camera complies with current European directives relating to electromagnetic compatibility and safety. (EMC directive 89/336/EEC; Low voltage directive 73/23/EEC).

### **Copyright**

© Wuhan Guide Infrared Co., Ltd, 2010. All rights reserved worldwide. No parts of the products may be reproduced, transmitted, transcribed or translated into any language or computer language in any form or by any means, electronic, magnetic, optical, manual or otherwise, without the prior written permission of Wuhan Guide Infrared Co., Ltd.

This manual must not, in whole or part, be copied, photocopied, reproduced, translated or transmitted to any electronic medium or machine readable form without prior consent, in writing, from Wuhan Guide Infrared Co., Ltd.

---

## Table of the Contents

Table of the Contents .....	1
Introduction .....	1
Precautions .....	1
Maintenance .....	1
Calibration and Repair Philosophy .....	2
Technical Support .....	2
Feedback to Us.....	2
System Overview .....	2
System Configuration .....	2
Technical Specification.....	3
System Features.....	5
Parts Described .....	6
EASIR-9 Charging Instruction .....	9
Buttons Introduction .....	10
Function operation .....	错误! 未定义书签。

## Introduction

This publication provides the necessary information required to safely operate the **GUIDE® EASIR-9** Thermal Camera.

It is important to fully check all equipment with which you have been supplied.

The equipment should be used, maintained and serviced by suitably trained personnel, capable of carefully following the procedures and guidelines given in this User Manual.

All User Manuals and leaflets should be read thoroughly before proceeding with operation of the equipment.

It is also advisable that all User Manuals and Instruction Leaflets supplied are kept readily available, for reference when the equipment is in general use.

## Precautions

The following precautions must be adhered to at all times and must be considered in addition to any advised precautions issued at the relevant worksite or work area.

- Keep the **GUIDE® EASIR-9** Thermal Camera steady during operation.
- Do not use the **GUIDE® EASIR-9** Thermal Camera in temperature exceeding its working and storage temperature ranges.
- Do not direct the **GUIDE® EASIR-9** Thermal Camera at very high intensity radiation sources such as the sun, carbon dioxide lasers or arc welders etc.
- Do not expose the **GUIDE® EASIR-9** Thermal Camera to dust and moisture. When operating the unit near water, ensure that the unit is adequately guarded against splashes.
- When the **GUIDE® EASIR-9** Thermal Camera is not in use or is to be transported, ensure that the unit and its accessories are stored in the protective carry case.
- Do not jam the holes or loudspeaker on the camera body.
- Do not re-switch on the camera until 15 seconds later after switching it off.
- Do not throw, knock or vibrate intensely the camera and its components in order to keep them from damage.
- Do not attempt to open the camera body, as this action will void the warranty.
- Keep the SD memory card for the exclusive use of the camera.

## Maintenance

To ensure that the **GUIDE® EASIR-9** Thermal Camera is kept in good working condition and remains fully operational, the following guidelines should be adhered to at all times.

### Non-optical surfaces

The non-optical surfaces of the camera can be cleaned when required, with a soft cloth dampened with water and a mild detergent.

### Optical surfaces

The optical surfaces of the camera lens should only be cleaned when visibly dirty. Care should be taken to avoid touching the exposed lens surface, as skin acid left behind from fingerprints can be damaging to coatings and lens substrates. Use only a proprietary lens cleaning tissue.

## Calibration and Repair Philosophy

To ensure the accuracy and reliability of the **GUIDE® EASIR-9** Thermal Camera, it is highly recommended that the instrument be calibrated at 12 monthly intervals.

Calibration or repair for the instrument can be obtained by either contacting the address/ telephone number on the cover of this User Manual, or by email to the following addresses: [overseas@guide-infrared.com](mailto:overseas@guide-infrared.com)

### Caution

The **GUIDE® EASIR-9** Thermal Camera does not incorporate any user serviceable parts. Never attempt to disassemble or modify the camera. Opening the unit invalidates the warranty.

## Technical Support

Technical support for your **Wuhan Guide** Thermal Imaging System can be obtained by either contacting the address / telephone number on the cover of this User Manual or by email to the following address: [overseas@guide-infrared.com](mailto:overseas@guide-infrared.com)

## Feedback to Us

We have tested and verified the information in this manual to the best of our abilities. Yet as we are committed to continuous development and progress, you might find features of the product have been changed since the time of printing. You are appreciated to let us know about any error you find, and your suggestions for further editions by either contacting the address/telephone number on the cover of this User Manual or by email to the following address: [overseas@guide-infrared.com](mailto:overseas@guide-infrared.com)

## System Overview

**GUIDE® EASIR-9** is a new infrared camera of Guide infrared, breaks the IR world with its lowest price and high performance. Designed for tough work environments and entry-level users, EASIR-9 is far more robust and shock-resistant for any tough working environment and it is easy to operate and allows for the learners to operate without being trained and take the inspection work easily with one hand .Featured with latest Infra Fusion technology, it helps you pinpoint the problem exactly with the most efficiency. Power on the EASIR-9, let the 3.6" LCD bring you into the fresh IR world

## System Configuration

Please ensure that the following items have been correctly supplied:

- IR Camera with visual camera, laser locator and illuminator.
- 25mm IR lens standard
- 3.6" TFT LCD with high resolution
- 4GB SD card & card reader
- 6 AA rechargeable batteries

- AC Adapter & cable
- USB extension cable
- USB driver
- Guide IrAnalyser® Software
- User manual
- Carry case & strap

**Options**

- 13mm wide angle lens
- 42mm and 70mm , two tele lens are available
- 8GB SD card
- Extended temperature range up to +1500°C
- Sun Shield
- Tripod mount

**Technical Specification**

<b>Imaging Performance</b>	
THERMAL	
Detector type:	Uncooled FPA microbolometer (384 × 288 pixels, 25µm)
Spectral Range:	8-14µm
Thermal Sensitivity:	≤100mk at 30°C
Field of View/ Focus:	21.7°X16.4°/ 25mm standard (40.53° X30.96° /13mm, 13.04° X 9.8° / 42mm, 7.85° X 5.89° /70mm optional)
Focus:	Manually
Electronic Zoom:	X2
VISUAL	
Built-in Digital Video:	CMOS Sensor, 1600×1200 pixels, 2 <sup>24</sup> true colors
<b>Image Presentation</b>	
External Display:	3.6" TFT LCD with high resolution
Video Output:	PAL/ NTSC
Infra Fusion:	Visual and IR blending
<b>Man-Machine Communication</b>	
Buttons:	Respond as per operators' operation
Menu:	Microsoft® Windows style
<b>Measurement</b>	

Temperature Range:	-20 °C to 250 °C (350 °C and 1500 °C are optional) 10 °C~50 °C (medical version)
Accuracy:	± 2°C or ± 2% of reading
Emissivity Correction:	Variable from 0.01 to 1.00 (in 0.01 increment)
Measurement Features:	Automatic correction based on distance, relative humidity, dew point function, atmospheric transmission and external optics
Optics Transmission Correction:	Auto, based on signals from sensors
<b>Image Storage</b>	
Type:	Removable 4GB SD card & built-in memory (8GB SD card optional)
File Format:	JPG with analysis records
Voice Annotation:	Up to 60 seconds
<b>Laser Locator</b>	
Classification	Semiconductor A1 GaInP Diode Laser
<b>Power System</b>	
Battery Type:	AA rechargeable battery, field-replaceable, AA Alkaline battery also usable
Charging System:	In camera or in battery charger
Battery Operating Time:	Over 2 hours continuous operation
External Power Operation:	AC adapter 110/ 220 VAC, 50/ 60Hz
<b>Environmental Specification</b>	
Operating Temperature:	-10 °C to 50 °C
Storage Temperature:	-20 °C to 60 °C
Humidity:	Operating and storing 10% to 95%, non- condensing
Encapsulation:	IP54 IEC 529 housing
Shock:	Operational: 25G, IEC 68-2-29
Vibration:	Operational: 2G, IEC 68-2-6
<b>Interfaces</b>	
USB 2.0:	Real-time image ( thermal & visual ) , measurement, and voice transfer to PC; Live video transfer to PC
<b>Physical Characteristics</b>	
Weight:	1KG(including battery)
Size:	112mmx182mmx252mm ( with 25mm lens )
Colors	Yellow & grey interlaced or red & grey interlaced alternative

## System Features

### Unique Features

- Rugged housing and rubber protection offers high effective operation even in harsh environment
- High thermal sensitivity 384x288 and precise temperature measurement
- Big 3.6" LCD plus three-button button system make for a friendly navigation with the push of a thumb
- Unique ergonomically handle presents the comfortable feeling
- Infra Fusion technology allows the overlay of the thermal image directly to the corresponding visual image
- 2.0 Megapixels CMOS delivers extremely crisp visual image.
- Auto gate which works as both shutter and intelligent lens cap prevents all disturbing heat radiation caused by optics and electronics inside, delivers crisp and uniform images and protects the precise lens.
- Auto focus function enables the auto focus of IR and visual image with simply pressing one button
- Quar-optoelectronic in one (One model includes IR lens , visual camera, laser locater and illuminator)
- Real-time radiometric thermal video recording and JPG image storage facilitate further analysis and report generation.
- Manually focus for accurate targeting and easy operation
- Availability of various exchangeable lens.
- Ultra large capacity SD memory card and built-in flash memory offer easy in-field storage.
- High-speed USB2.0 interface enables real-time data transfer and camera control.
- Robust on board analysis enhances operators' efficiency & productivity.
- High availability of AA Alkaline battery ensures the uninterrupted high efficient work
- Low cost enables the ownership of everyone.

### Imaging Performance

- Manual focusing of IR lens.
- Zoom in or out thermal image x2.

### Temperature Measurement

- Auto calibration ensures high accuracy.
- Auto hot-spot tracing and center-cursor temperature measurement pinpoint the problem.

### Image Storage

- Live images can be frozen to be static images
- Frozen images, comprising radiometric data, infrared image, visual image, voice annotation can be saved into 4GB SD card or the built-in flash memory in standard JPG format.
- Up to 60-second digital clip of voice can be recorded and saved for each image.
- SD card can accommodate 1000 images and the built-in flash memory can store 100 images.

### Image Playback

- Images saved into SD card or the built-in flash memory can be replayed on the camera.
- Temperature measurement can be done on replayed images.



- Voice annotation and visual images saved together with thermal images can be replayed as well.
- Images saved in SD card and the built-in flash memory can be downloaded to PC for further analysis and report generation with software Guide IrAnalyser<sup>®</sup>

**Parts Described**

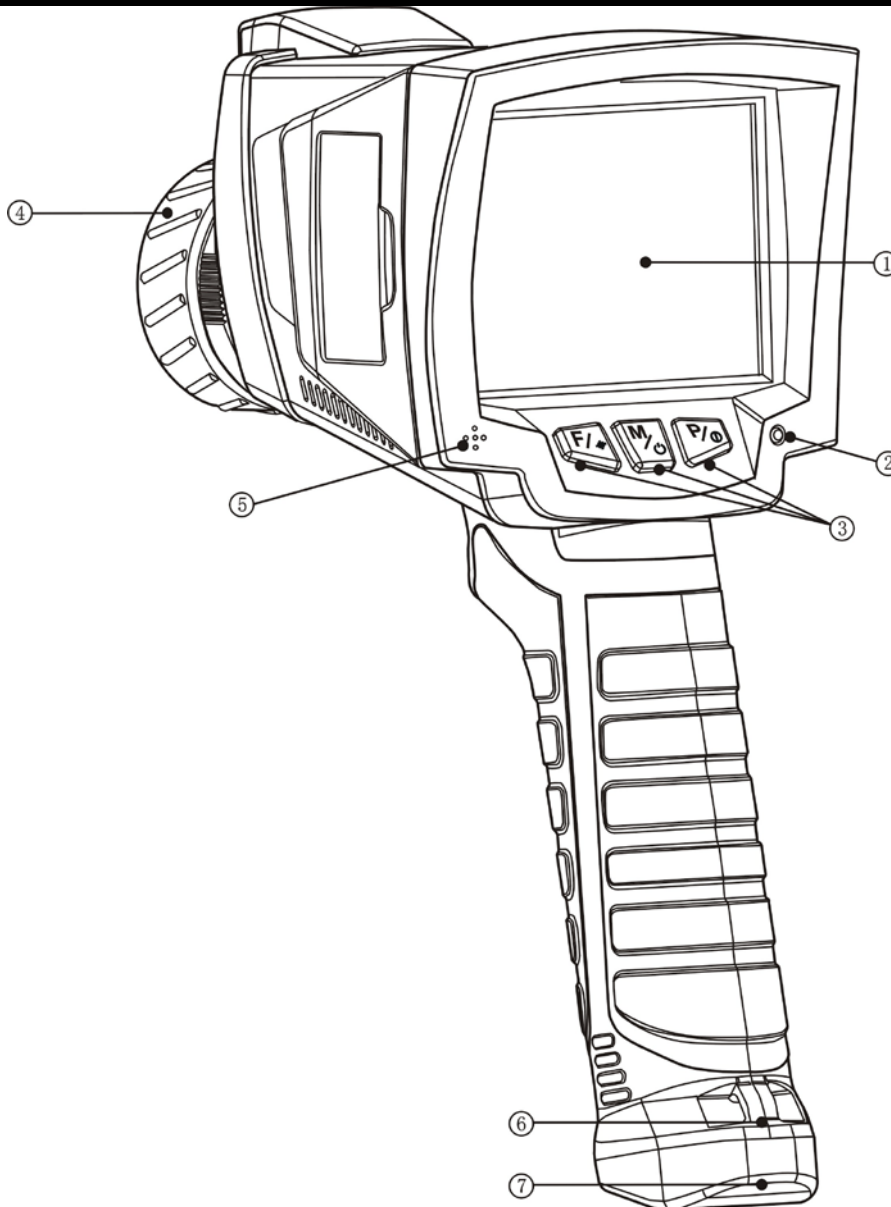

1	LCD Display
2	Charging Indicator
3	Function Softkeys
4	Manual focus lens
5	Microphone
6	Battery Cover
7	Speaker

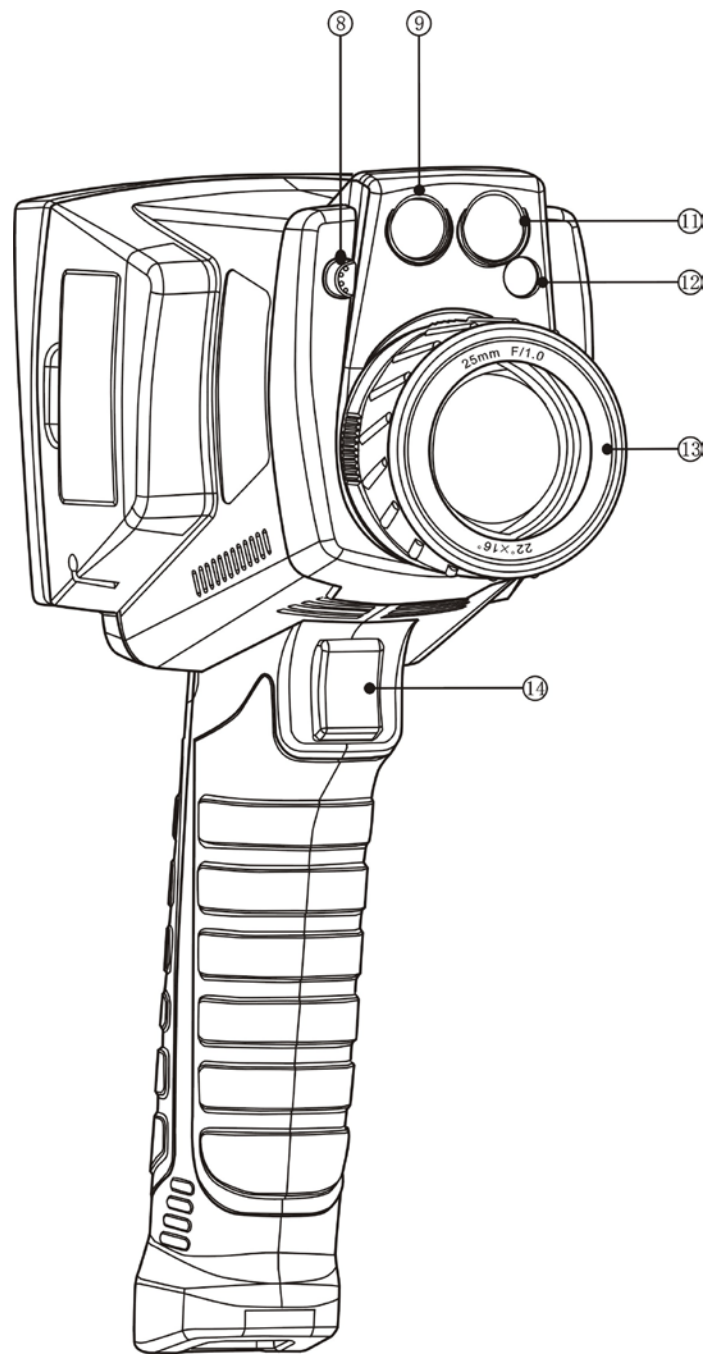

8	Lens lock
9	Visual Camera
11	Illuminator
12	Laser
13	IR Lens
14	Trigger Button

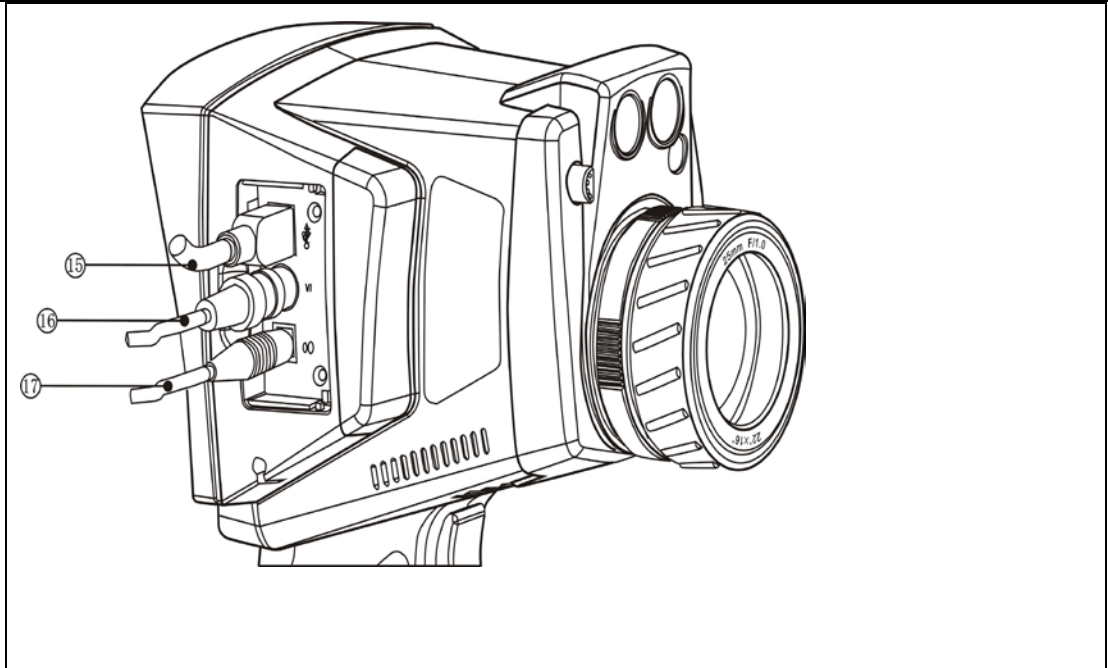

15	USB Interface
16	Video Interface
17	AC Adapter/Charging Input Terminal

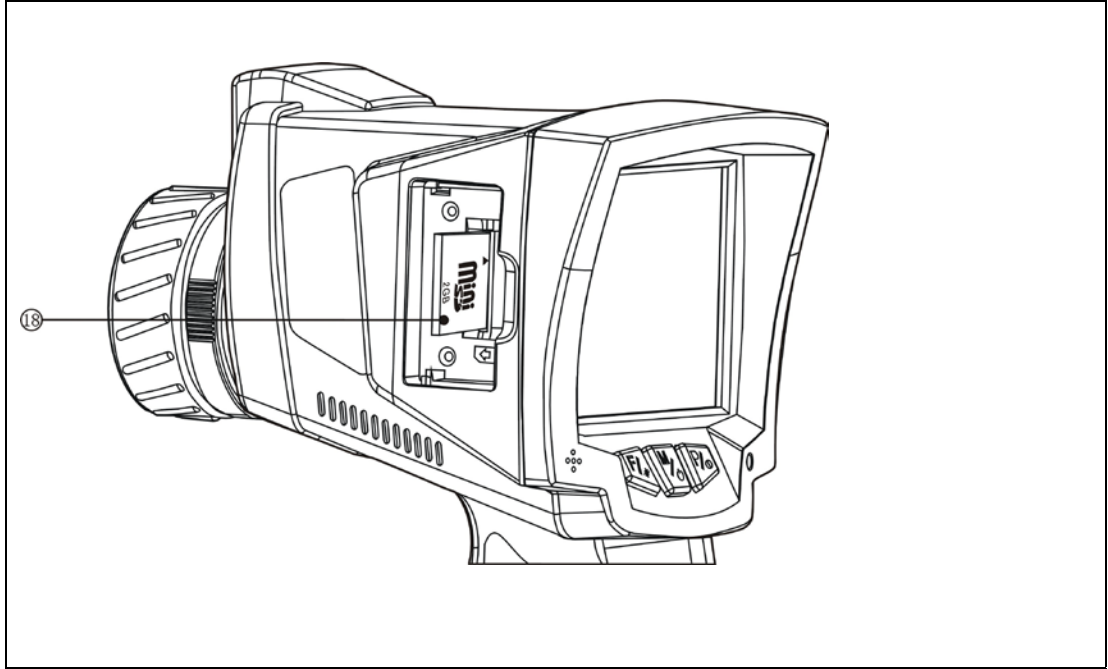

18	SD Card Slot
----	--------------

## EASIR-9 Charging Instruction



Note:

- “Instruction” is only for 2704D PCB
- “slow flicker” in the text is about 1Hz, “quick flicker” is about 3Hz

### How to use the adapter

- The red indicator light will flicker when the adapter is connected with camera. Keep press the button  for 3 seconds to power on the camera with the green and red light flicker alternatively. When entering self-check interface, the indicator turns to be red and constant on

- Press button  to power off the camera, the adapter indicator will be constant on.



Note:

- When using the adapter, the indicator will be constant red for both powering on and off.

### How to use the batteries

- Insert the batteries, the indicator will not flicker at once. Press button  to make the red indicator flicker , after 2 seconds , the indicator will alternatively flickers as green and red and stop when entering the self-check interface. (If the camera is powered on when battery is low, the red indicator will flicker quickly and power off automatically.
- When using the camera, if the batteries consume to the lowest limitation, the red indicator will flicker for a moment then power off automatically.



Note:

- When using the battery , only when powering on and in the low battery condition, the indicator will light on.

### How to charge with batteries

- Charge when power off
  - Insert the batteries and connect the camera with the adapter to start charging when the red indicator flicker slowly
  - (Charge when power off) Press button  for 2 seconds, the indicator will alternatively flickers as green and red and the red indicator will flicker slowly when entering the self-check interface
  - When the batteries are fully charged, the green indicator will flicker slowly.



Note:



- When charging, red indicator flickering means there is errors in charging process, please check out whether the batteries are correctly inserted into the camera and meet the battery requirement or exceed the highest temperature limitation. (the limitation is about 60°C)
- Charge when power on
  - Power on when using the batteries, then connect the camera with adapter, the red indicator will flicker slowly.

- (When charging Press button  to power off the red indicator will flicker slowly
- After charging, green indicator flickers slowly.



 Note:

- The batteries cannot be taken out of the camera in the power-on charging process.
- Defect: When there is a circuit break or damage in the thermal resistor which detects the charging temperature of the batteries, the batteries cannot be charged.

**Buttons Introduction**

There are three functional buttons of **GUIDE® EASIR-9** (From left to right, they are ,  and ) and a trigger button “T”.

**Power on /off the camera**

The input voltage is 12V, keep button  depressed for more than 3 seconds to power on. When powering off, keep the button  depressed until the switch off bar runs fully. To release the button  at any time before the switch off bar runs fully to leave the power off state.





**Focus and Image zoom**

On the non-menu mode, rotate the lens manually until you get a focused image. When doing manually focus, please keep the camera steady, to ensure high accuracy.



On the non-menu mode, press the button to zoom in the image to x2, with the current magnification shown at the up left corner of the screen.











**Quick function**

On the non-function mode, press button  shortly to enter key functional menu, the following info will be displayed on the screen :

Visual	Spot	Fusion	
			

- Press  to enter spot analysis mode

↑/←	↓/→	L/R / U/D
		

- Press  to switch between the X or Y coordinate
- Press  or  to adjust the value of X or Y's coordinate..
- Press T to exit the spot analysis and return the real-time IR mode.
- Press  to enter visual light/Infra Fusion mode:
  - On the fusion mode, press  or  to adjust the proportion of fusion
  - On the fusion mode, press  to enter temperature fusion, the fusion range will be displayed at the bottom Of LCD, press Trigger button and  to switch between the lowest temp and highest temp. Then press  or  to adjust the temperature value.
  - On the fusion mode, press T to return the real-time IR mode. The proportion will be saved as the default value when start up the fusion mode next time.





**Laser On/Off**

On the non-menu mode, keep  depressed for 2 seconds to turn on /off the laser (Ensure the Laser is "On" in the menu of Parameter)

**Manual calibration**

On the non-menu mode, keep pressing "T" button and then press  button to run shutter calibration

**Illuminator On/Off**



On the non-menu mode, keep pressing  and  to enter the light illuminator function, press  to turn on the light and increase the light intensity (total 3 levels), press  to decrease the light intensity till it is turned off. Press  saves the settings and exit.  
Press button T return to real-time IR mode

**Dew-point Function**

On the non-menu mode, keep pressing button  and  , the Dew-point value shows at the bottom of LCD, press button T return to real-time IR mode



**Selecting Span**

- Keep button  pressed for 3 seconds to enter span selecting mode.



- Press  to select AutoSpan 1.
- Press  to select AutoSpan 2.
- Press  to select ManualSpan

**Image frozen and save**



On the non-menu mode, press T to freeze the image, the following info will be displayed on the screen:

Save	Voice	Visual
		

Press T again to exit frozen mode and return to the real-time IR mode, or

- Press  to save the image and return to live thermal image
- Press  to add the voice annotation, the following info will be displayed on the screen:



xx s

Record	Stop	Play
		

Press  to start recording voice annotation;

Press  to stop recording voice annotation, the following info will be displayed on the screen:

xx S



Record	Save	Play
		



Press  to play the voice annotation



- Press  to enter visual light mode, press again to return IR mode.
- Press T to return to real-time IR mode.

**Setting Contrast & Brightness**

On the non-menu mode, keep the  pressed for 3 seconds to enter the Contrast and Brightness setting. The following info will be displayed on the screen:

AutoSpan 1	AutoSpan2	ManualSpan
		



Press  or  to choose AutoSpan1 or AutoSpan2.

Press  to enter manual adjust mode, then press  or  to increase/decrease the value of Tmax and Tmin, the picture effect will change accordingly.

Press button T to finish operation and return to real-time IR mode

**Main menu operation**

On the non-menu mode, press  to bring up Main menu, the following info will be displayed on the screen:

Parameter	File	Setup
		

Press T in the main menu to return real-time IR mode;

- On the main menu mode, press  to enter sub-menu of parameter setting:

Emiss		
Tamb		
Distance		
Palette		
RelHum		
Laser		
Brightness		
↑	↓	OK

On the sub-menu mode, press  to confirm selecting the highlighted option and enter the next sub-menu, press T to exit main menu operation and return to real-time IR mode.

- On the main menu mode, press  to enter file operation sub-menu :
- 

Filelist		
Del All		
Video		
Storage		
Help		
About		
↑	↓	OK



On this sub-menu mode, press  to enter next sub-menu, press T to exit main-menu operation and return real-time IR mode.

- On the main menu mode, press  to enter system setting sub-menu:

Default		
Lang		
Tunit		
TimeDate		
Lens		
Pal/Ntsc		
Sleep		
↑	↓	Ok

On the sub-menu mode, press  to confirm selecting the highlighted option and enter the next sub-menu, press T to exit main-menu operation and return real-time IR mode.

## Function operation

### Thermal camera focusing

Manual focus:

Aim at the target and adjust the lens until the image on the LCD is as clear as possible

### Image capturing and saving

- Aim the lens at the target of interest and adjust the focus manually to get a clear image on the LCD, and then pull the trigger button to capture an image. The image will be frozen and bring up the image capture menu.
- Press “Save” to save the image. If the SD card is in the camera, the image data will be acquiescently saved in the SD card.





### Selecting the Palette

- Press  to display the main menu.
- Press the “Parameter”
- Select “Palette” by pressing “↑” and “↓”, and “OK” to confirm.





- Press  or  to shift among different palettes

- Press  to confirm

**Setting Tmin and Tmax**







- Keep button  pressed to enter span selecting mode.
- Press  to select ManualSpan
- Press  to increase the Tmax value, press  to decrease the value, press  to switch to Tmin adjustment mode.
- The same operation for Tmin adjustment.
- Press button “T” to save and exit.

**Setting LCD brightness**

- Press  to display the main menu.
- Press the “Parameter”
- Select “Brightness” by pressing “↑” and “↓”, and “OK” to confirm.
- Press  or  to adjust the LCD brightness
- Press  to confirm.

**Picture Mode and Infra Fusion**

The **EASIR-9** could be displayed in full visual mode, full thermal mode and the confusion mode, they could be switched.

- On real-time thermal mode, press the button of  to go into the picture mode, it would appear “Visual”, “Spot” and “Fusion” on the button of the LCD screen
- Press the button of  to enter into the visual mode
- Press “Trigger” to switch to the real-time thermal status
- In the picture mode with the menu of “Visual”, “Spot” and “Fusion” displayed on the screen, press  to go into the fusion mode.
- Press button  and button  to adjust the fusion percentage, from full visual to full fusion.
- Press “Trigger” to switch to the full thermal image.
- In real-time status, press “Trigger” to froze thermal image, it would appear “Save”, “Voice” and “Visual” at the button of the LCD screen. Press  to switch between thermal image and visual image
- When replaying a thermal image, there would appear “Delete”, “Voice” and “Visual” at the bottom of the LCD screen, Press  to switch between the thermal image and visual image

### Reviewing and Deleting Stored Images

To view stored images on the SD card:

- Press  to display the main menu.
- Press the "File".
- Select "Filelist" by pressing "↑" and "↓", and "OK" to confirm
- Press "←" and "→" to toggle between different images, and press "Select" to choose the selected image.





### To delete a single image from the SD card

- Perform the steps under viewing stored images above to bring the desired image to the display.
- Press the "Delete".
- Press the "Yes".



### To delete all the images from the SD card



- Press  to display the main menu.
- Press the "File".
- Select "Del All" by pressing "↑" and "↓", and "OK" to confirm.
- Press the "Yes".

### Video recording

- Press  to display the main menu.
- Press the "File".
- Select "Video" by pressing "↑" and "↓", and "OK" to confirm.
- Press button  to start recording
- Press button  to stop and save the recording, press button  to re-play the recording.
- Press T button return to real time IR mode.

### Auto sleeping mode

- Press  to display the main menu.
- Press the "Set up".
- Select "Sleep" by pressing "↑" and "↓", and "OK" to confirm.
- Press button  to make Sleep mode enabled

- Press button  and  to decrease/increase the time of sleep mode, sleep time is displayed at the bottom of LCD. Press  to save and confirm. Machine auto enter sleep mode after pre-set timing value, press any button activates the machine from sleeping mode.
- Press T button return to real time IR mode.

### Adding Voice Annotation to Saved Data

Voice annotation can only be added to an image prior to storing it. After capturing an image, the Image Capture menu appears. To add a voice annotation to the image:

- Press the “Voice”.
- Press “Record” to start the recording.
- Speak into the Imager’s microphone opening. When done recording, press the softkey labeled “Stop”. Up to 60 seconds of voice annotation can be recorded for each image. Once it reaches 60 seconds, recording will stop automatically.
- Press “Play” to replay the voice annotation before saving.
- Press “Save” to save the voice annotation.

### Listening to Voice Annotation



To play the voice annotation already stored with an image on the UFlash or SD card:

- Perform the steps in the “Reviewing and Deleting Stored Images” section to bring the desired image to the EASIR-9’s display.
- Press the “Voice”.
- Press the “Play”.

The saved voice annotation will be replayed through the imager’s speaker.



### Changing the Temperature Units



The EASIR-9 will display temperature in Fahrenheit or Celsius. To change the temperature units:

- Press  to display the main menu.
- Press the “Setup”
- Select “Tunit” by pressing “↑” and “↓”, and “OK” to confirm.
- Press  for Celsius or  for Fahrenheit.

### Doing spot analysis

EASIR-9 supports single spot measurement. The location of center spot can be adjusted in live image:

- Press  button and then  button to bring location adjustment mode of center spot.

- The default adjustment mode is “L/R” mode, press  and “M” button can move the center spot to left and right under this mode; press “P” button to switch into “U/D” mode, then press  and  button can move the center spot to up and down under this mode. Press “P” button can switch between the above two modes freely.
- Press “trigger” button can save and exit the location adjustment mode of center spot.

**How to get accurate temperature?**

There are a lot of factors affecting temperature accuracy.

Here is a brief introduction to some typical parameters: emissivity, background temperature, distance, humidity and etc.

 **Note:**

To get accurate temperature, you shall hold the camera stably and focus the camera well.

- **Emissivity:** All objects radiate infrared energy. The amount of energy radiated is based on two primary factors: the surface temperature of the object and the emissivity of object’s surface.



The default emissivity is 0.98, which is applicable to most surfaces.

For some special materials or surfaces, please refer to the emissivity table to find a right emissivity value.

You can change emissivity between 0.01 and 1.00 in menu Para and Emissivity.

- **Tamb:** To display and adjust the real-time comparative scene temperature of target. The default setting of this parameter is automatic adjusted by the internal temperature sensor. If needed, this setting can be adjusted manually according to real temperature of some special scenes (like sky or snow) of measured target.

Press  button and  button to bring the submenu of parameter setting, then choose “Tamb” and select

“Set” option to set the value manually by press  button and  button. The new measurement will be based on the saved tamb value until re-enter the “Tamb” option and exit, which will activate the default automatic mode.

- **Distance:** To set the proper distance from target, the distance range is from 0.1 meter to 50 meters.
- **Relative Humidity:** To set relative humidity percentage value between 0 and 100 according to the practical environment.

**Video Output**

Composite video output (PAL or NTSC mode) option is available in EasIR-9. With this option you can view the live image captured by the camera on a monitor or a recording device. Before trying to use this option, ensure that the EasIR-9 camera is switched off.

- Properly connect the camera to the monitor (or recording device) with the video cable supplied together with the camera..
- Power on the monitor.
- Power on the camera.

- Press  to display the main menu.
- Press the "Setup".
- Select "Pal/Ntsc" by pressing "↑" and "↓", and "OK" to confirm.
- Press the "PAL" or "NTSC" to select different output systems.
- When viewing the live image, you can still use the buttons to control the camera.
- After viewing the live image, power off the camera, monitor (or recording device) and disconnect the cable.

**Note:**

It is required to power off the camera before connecting it to a monitor or a recording device.

**Transferring Data from the Camera to PC**

- Before transferring data from the EasIR-9 camera to PC, ensure that the PC offers USB2.0 interface and the USB driver for the camera has been successfully installed in the PC.
- Power on the camera.
- Press the "File" to reveal the menu "Storage".
- Select "Storage" by pressing "↑" and "↓", and "OK" to confirm.
- Press the "UFlash" to select the storage medium as UFLASH. Press the "SD Card" to select the storage medium as SD Card.
- If the storage medium is set as "UFLASH", no hint will display on either the PC or the EasIR-9 screen. Image export, image analysis, live video recording etc. can be done in the PC. Images saved in UFLASH can be transferred to PC via IrAnalyser.
- If SD card is inserted in EASIR-9, the PC will identify the EASIR-9 as a removable hard disk, you can copy the saved data to PC or delete them from the card, or even format the SD card and etc. But you cannot operate on it in the Guide IrAnalyser software.
- If without SD card in EASIR-9, you have to install the camera USB Driver to PC, and use the Guide IrAnalyser software to transfer images to PC.

**Install USB driver to PC**

When there is no menu in the live thermal image, properly connect the USB interfaces of the camera to a USB2.0 port of your PC with the USB extension cable.

Microsoft® Windows launches a Found New Device Wizard to guide you to install the driver as follows:



- Choose “Install from a list or specific location (advanced)” and include the folder where you save the driver program. Then Click button next to go further.



- Installation starts. When getting to the step as shown below, choose “Continue anyway” to proceed further.

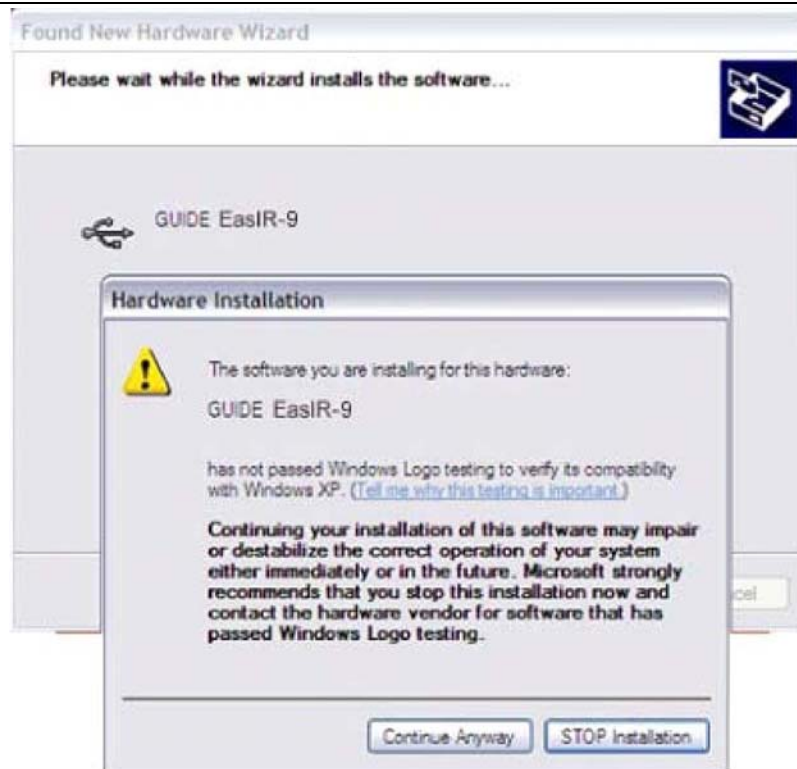

- Installation continues and finishes quickly. Click button Finish.



- Go to Device Manager to check and confirm whether the driver has been successfully installed. If there is "GUIDE EASIR-9" listed under Universal Serial Bus Controller, it indicates the driver has been properly installed and you can transfer data from the camera to PC now.
- The procedures to go to Device Manager is as follows: Clicking My Computer-> Clicking the right mouse and choosing Property-> Choosing menu Hardware in the System Property dialog box-> Choosing option Device Manager under the menu Hardware.



